

LED STREET LIGHT G4

AdvanLED



Product Specification

Model No.	AvL-SL-090W-35K G4
Lumen (lm)	11520
Efficiency (lm/W)	128
Power (W)	90
Colour Temperature, CCT (K)	3500K
Colour Index (CRI)	≥ 70
Beam Angle (°)	Asymmetrical
Weight (Kg)	± 10
Dimmable	No

General Specification

Input Voltage (VAC)	220 - 240
Power Factor (PF)	≥ 0.9
THD (%)	≤ 20
IP Rating	IP 66
Materials	Die-Cast Aluminium
Driver	External LED Driver (Within Casing)
Life Time (hours)	50,000
Warranty (years)	3
Finishing Color	Grey
Operating Temp. (°C)	-20°C ~ 50°C
Working Humidity (% RH)	10 ~ 90
Storage Temp. (°C)	10°C - 65°C

Features

- Spigot Opening : ≥66
- Depth : ≥ 100
- Adjustable Angle

Applications



Reference

Remark:

*Smart Solution sold separately

AdvanLED



LED STREET LIGHT G4

Photometric Result :

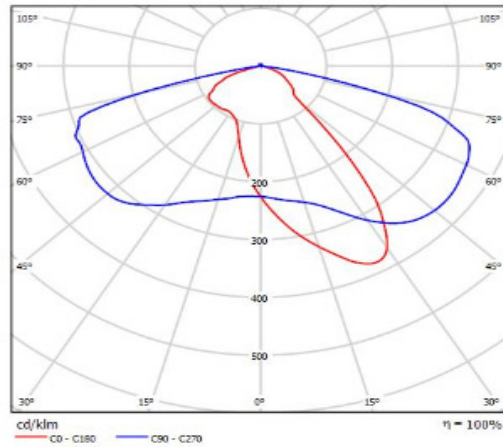

Asymmetrical

Dimension (mm):

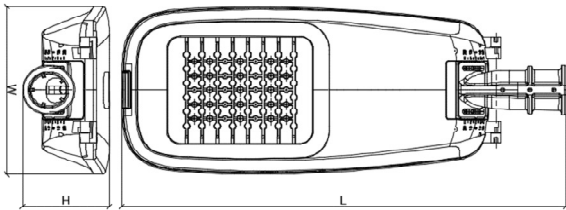

Length (L)	669
Width (W)	250
Height (H)	145

Installation Data / Driver Dimensions (mm)

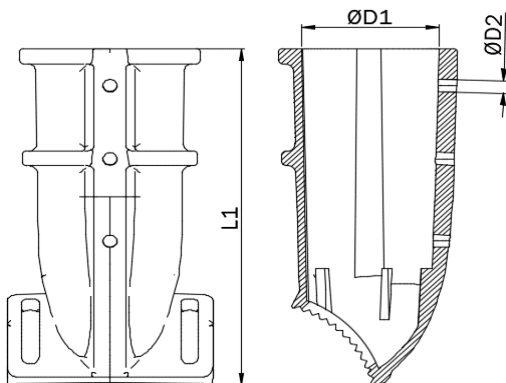

L1	184
ØD1	88
ØD2	2 x M10
Depth	100 ~ 110

*Smart Sensor Ready using standard ANSI C136.41 Nema 7 socket
 *kindly contact sales representative for more details

AdvanLED



Malaysian Brand MADE IN MALAYSIA